

Regional Cooperation between FR and JPN

～ From Industry/Business point of view ～

Haruyuki HIRATANI, PhD
TAKASAGO Electric, INC.

20th Nov. 2018, EU-Japan Centre for Industrial Cooperation

Who am I ?

- 1968 Born in Hiroshima (Nagoya, JPN)
- 1991-2018.9 M. Co., Ltd. (Medical Device)
- 1999—2001 Boston, USA
- 2013—2017 Strasbourg, France (President of M-FR SAS)
- 2018.10 Takasago Electric INC (Nagoya, JPN)



What I did/am doing with FR societies

M-FR

(Strasbourg, FR)



2013.4 ~ 2017.5

M-JPN

(Nagoya, JPN)



2017.6 ~ 2018.9

Takasago

(Nagoya, JPN)



2018.10 ~

M-FR (2013.4~2017.5)

Foundation: 1992

Manufacturing/Logistics of Medical Devices

Alsace, France

Employee: 45



M-FR (2013.4~2017.5) with AJA

1. Business in France

Expand our facility ▪ ▪ ▪ ▪ ▪ list up the candidate facility
negotiation with their owner/company

2. Life in FR for Japanese

JPN's supplementary school ▪ ▪ ▪ ▪ ▪ Audit by **URSSAF**

(social security expense correction agency)



M-JPN (2017.6~2018.9)

Coffee grounds Recycling loop in JPN

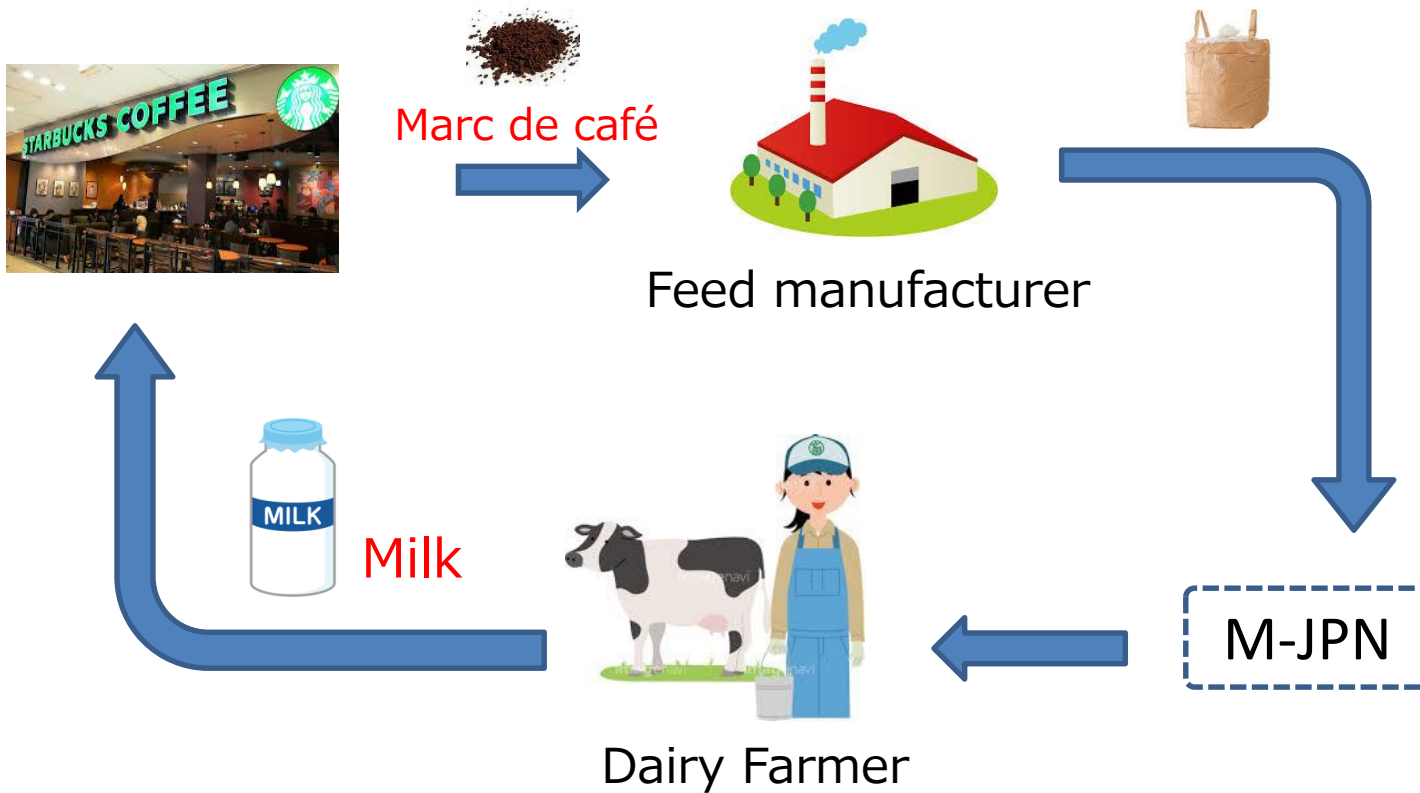

M-JPN (2017.6~2018.9)

with Business France

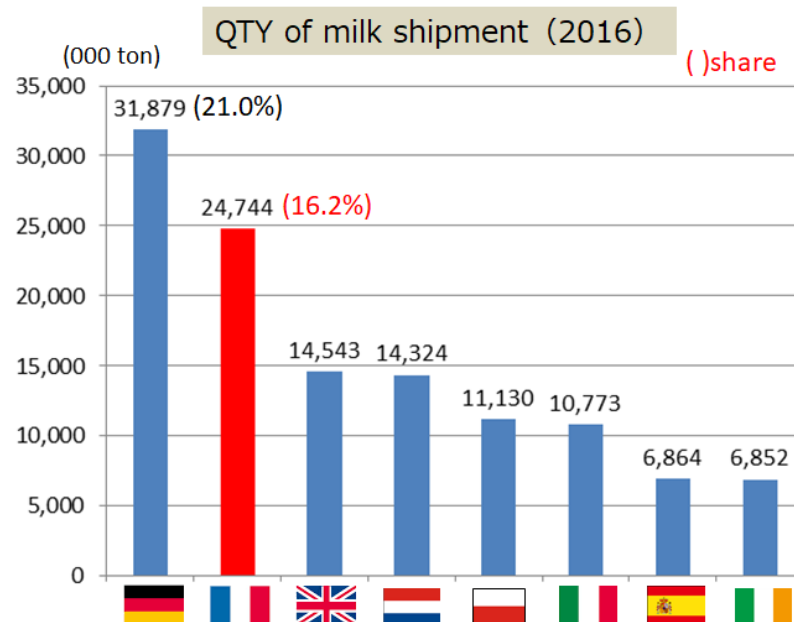
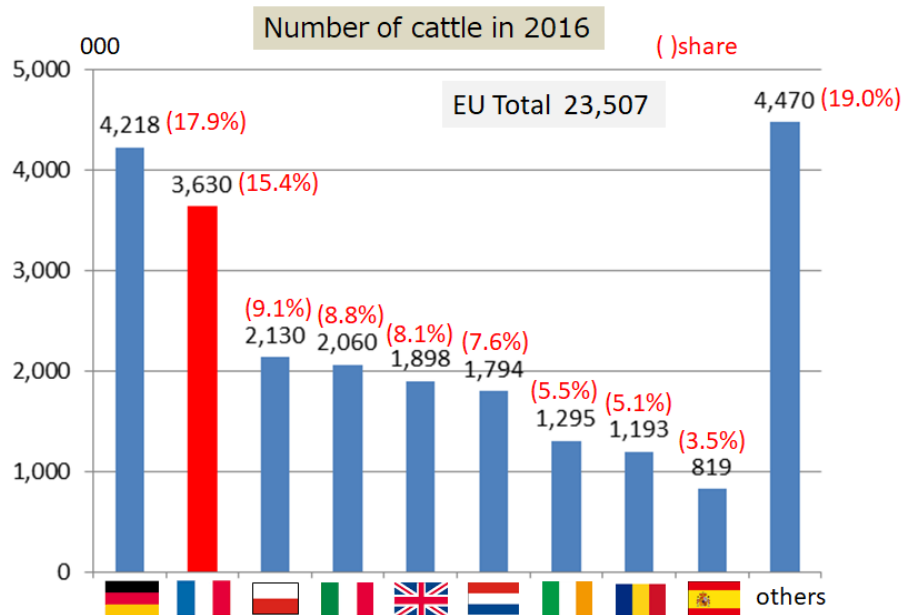

Dairy Industry
Global Market
Share

年度・順位			メーカー名	拠点	'16 売上高 (10億US\$)
'14	'12	'10			
1	1	1	Nestle (ネスレ)	スイス	27.4
2	3	4	Danone	仏	20.9
3	2	2	Lactalis	仏	20.5
4	4	3	Dairy Farmers of America	米国	15.4
5	6	7	Friesland Campina	オランダ	14.0
6	5	5	Fonterra	ニュージーランド	13.7
7	7	8	Arla Foods	デンマーク	11.3
8	9	11	Yili	中国	10.3
9	8	6	Saputo	カナダ	9.6
10	12	19	Mengniu	中国	9.4

15 % des vaches laitières en Pays de la Loire en 2016

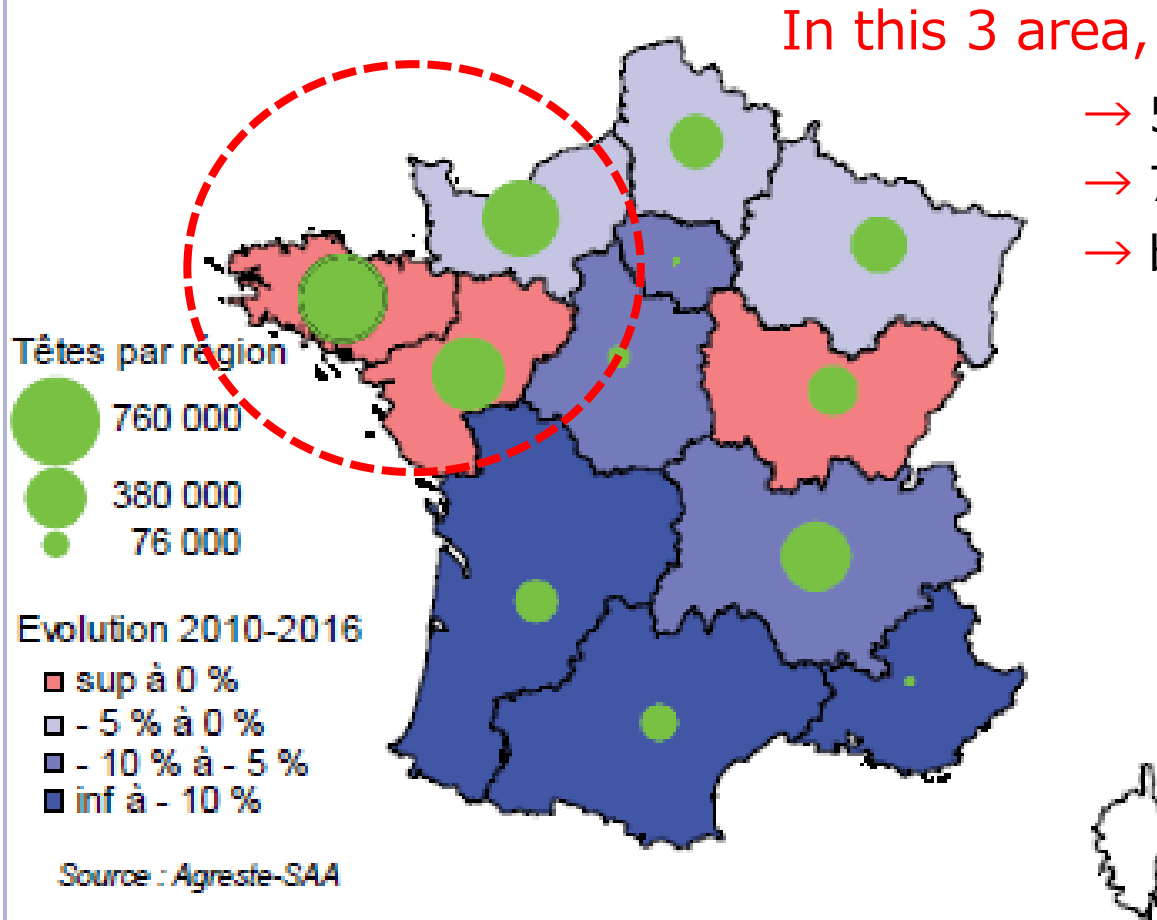

- 57% total cow
- 70% total feed company
- big 3 coffee factory

exist

Takasago (2018.10~)



About TAKASAGO Electric, Inc.



Our Products

Small size of Valves and Pumps



Precise Control of Gas and/or Liquid

Company Overview

TAKASAGO has provided more than 8,000 different solenoid valves and other fluidic control components over the last 50 years.

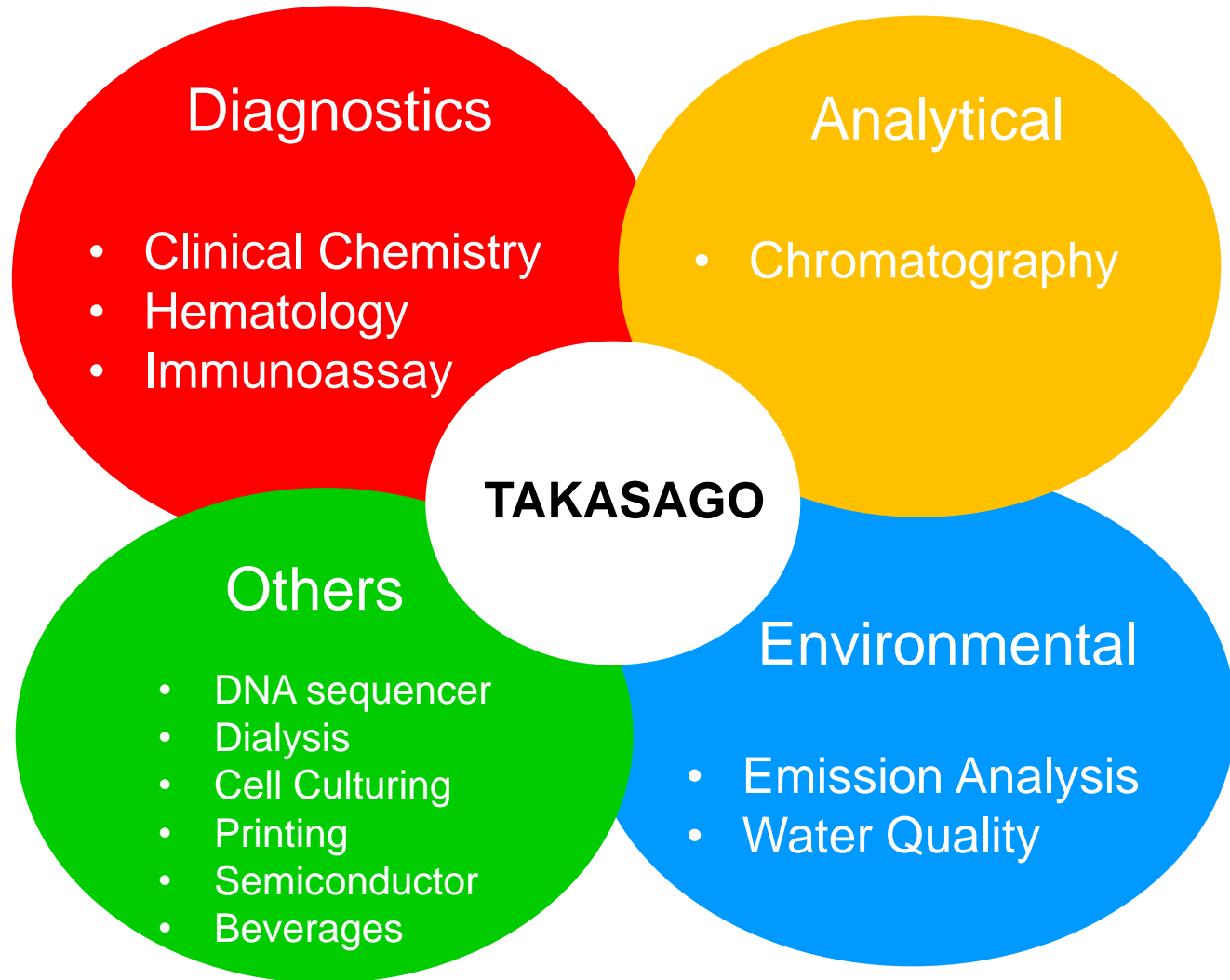

Our Strength

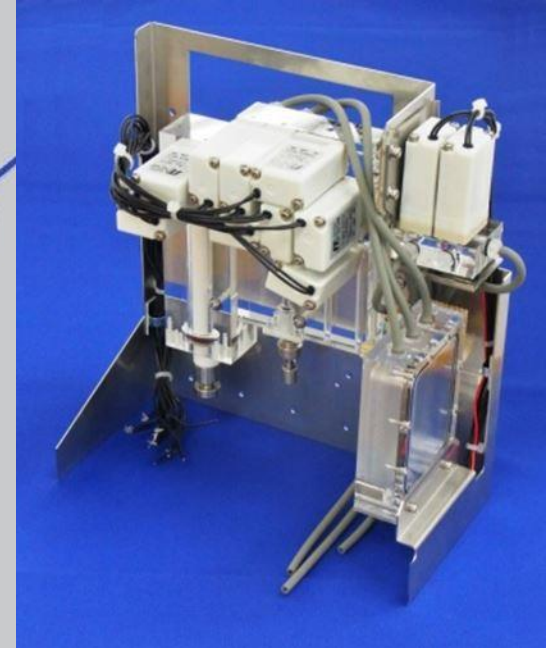
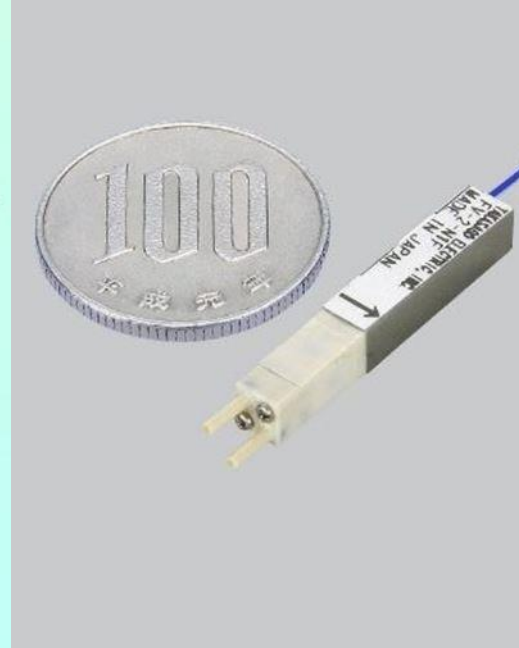
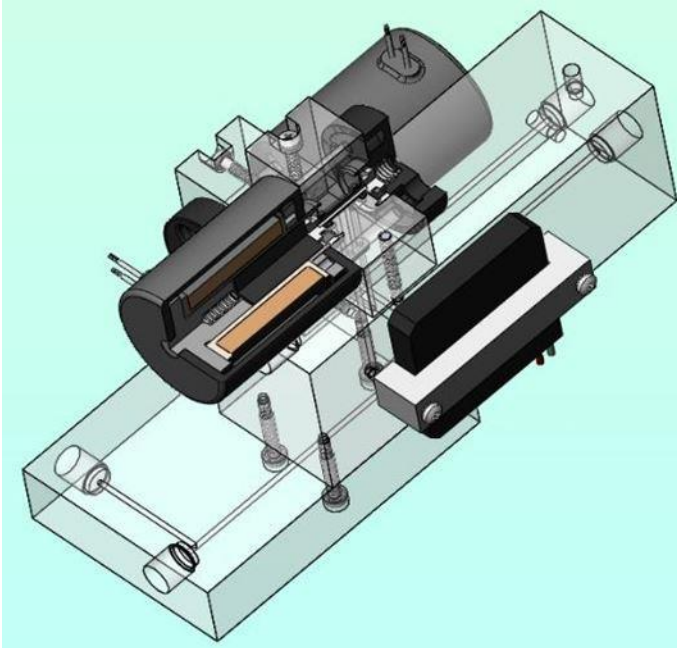

Customization

Miniaturization

Integration

New Business

- Aerospace field

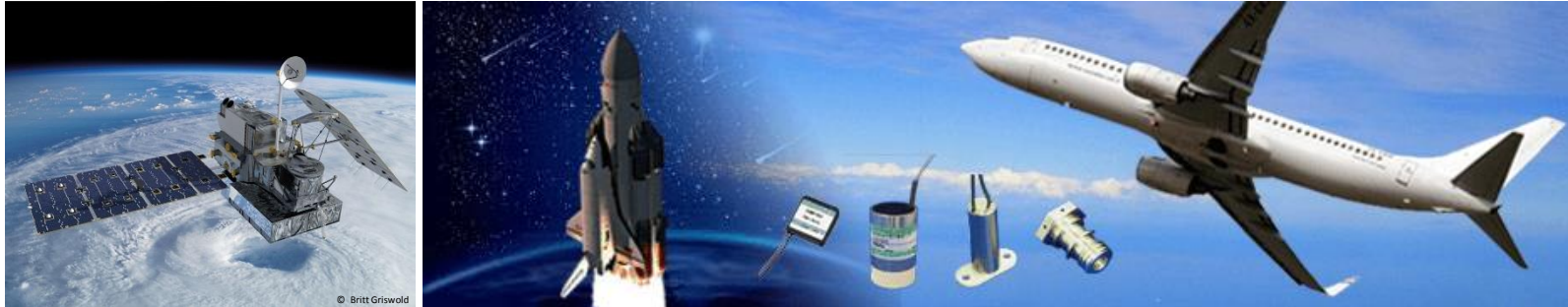

- Tissue engineering field

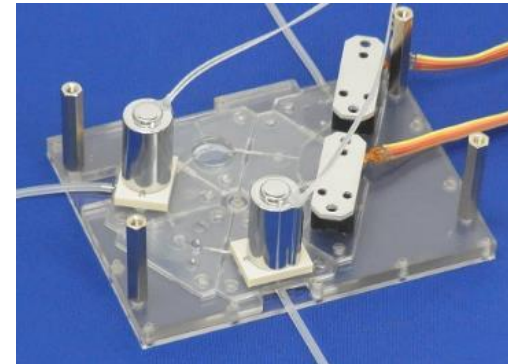

Asking A.J.A. for their support/coordination with Loco business partners

Thank you for your attention !!